

Monoline 36-gal Litter Bin

Clean lines and clean streets is what the Monoline Litter Bin is here for. Available in multiple sizes to handle all your messy needs.



- all aluminum frame construction
- available in trash, recycle, and compost options
- plastic liner(s) included
- powder coated finish
- single stream + dual stream options
- surface mount or freestanding
- pre-drilled holes for surface mounting
- aluminum or wood inserts for doors
- customized laser-cut branding optional
- heavy-duty hinge w/ universal door lock

PRODUCT:	LENGTH:	WIDTH:	HEIGHT:	CAPACITY:
ML-LGLITTER	27"	14"	42"	36 GAL.
ML-LGLITTER-DL	27"	14"	42"	(2) 18 GAL.



PRODUCT SPECIFICATIONS

ALL ALUMINUM FRAME CONSTRUCTION

POWDER COAT COLOR

(FRAME): _____

(ICON): _____

MOUNTING TYPE:

SURFACE MOUNTED

RISER MOUNT

EMBEDDED

PRODUCT SHIPS FULLY ASSEMBLED

MOUNTING HARDWARE NOT INCLUDED

SEE INSTALLATION SHEET FOR ADDITIONAL

INFORMATION

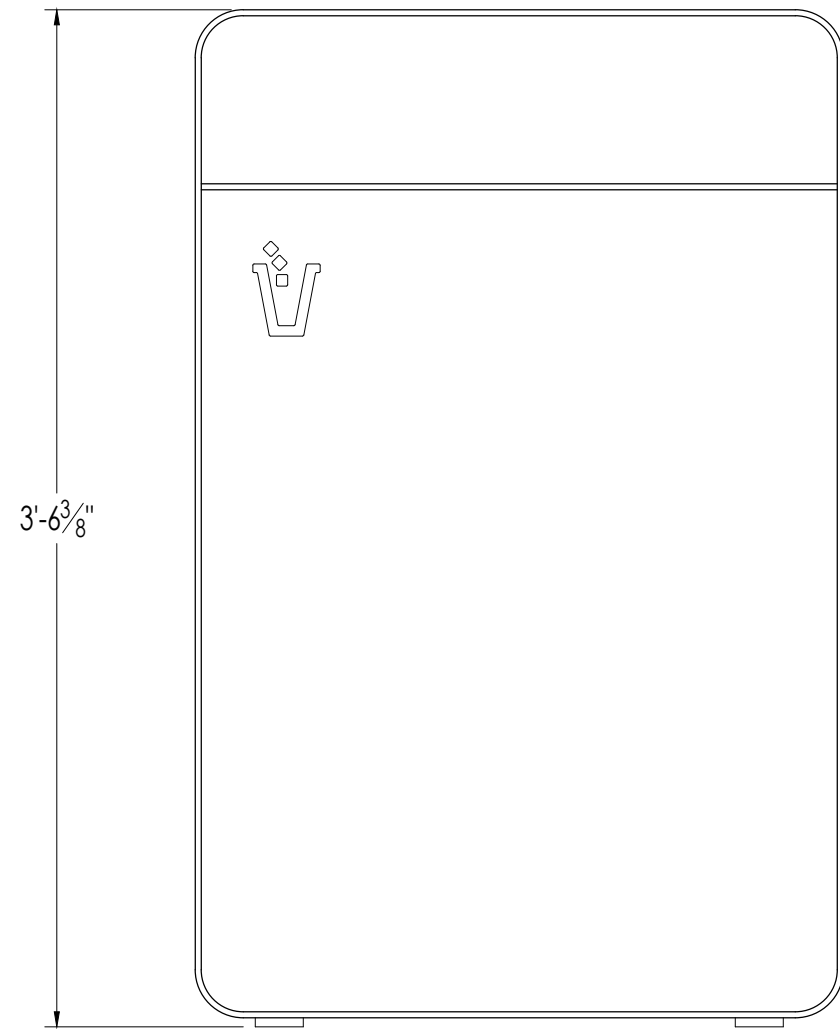
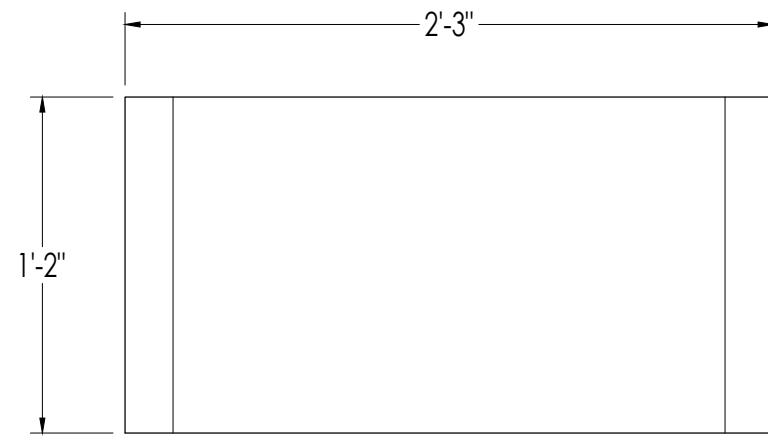

BACK

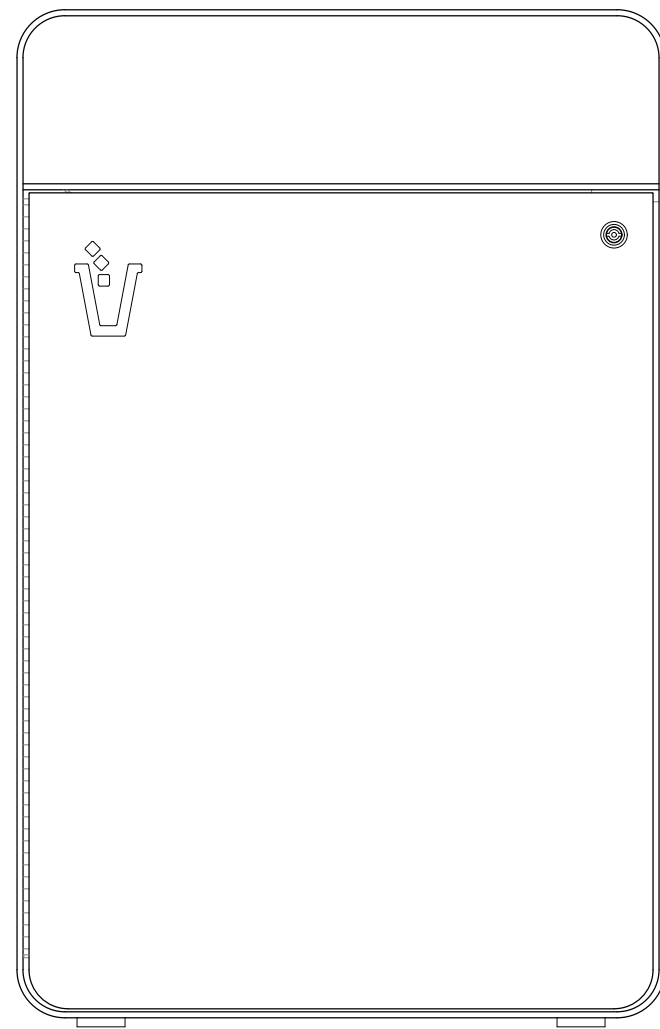

FRONT

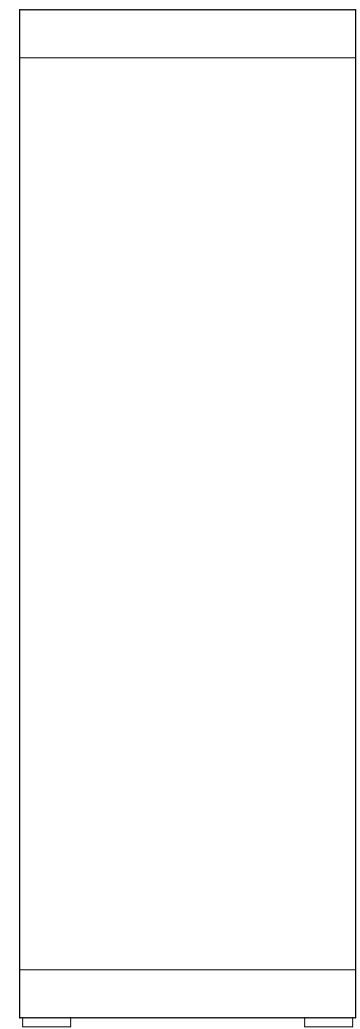

site pieces

ALL DIMENSIONS ARE NOMINAL
ANY AND ALL INFORMATION ON THIS DRAWING
MAY BE PROPRIETARY TO SITE PIECES, LLC
AND MAY NOT BE COPIED OR ALTERED WITHOUT
PERMISSION FROM SITE PIECES, LLC.
3575 RINGSBY COURT #418 DENVER, CO 80214

PRODUCT: MONOLINE 36-GAL LITTER BIN - TRASH
PRODUCT #: ML-LGLITTER-T

SIZE: 27" X 14" X 42"
APPROXIMATE WEIGHT: 55 LBS
SCALE: 1-1/2"=1'0"

CREATION DATE: 2022-02-24
UPDATED: 10/30/2024

SHEET: 1/1

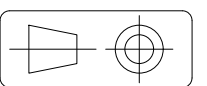

PRODUCT SPECIFICATIONS

ALL ALUMINUM FRAME CONSTRUCTION

POWDER COAT COLOR

(FRAME): _____

(ICON): _____

MOUNTING TYPE:

SURFACE MOUNTED

RISER MOUNT

EMBEDDED

PRODUCT SHIPS FULLY ASSEMBLED

MOUNTING HARDWARE NOT INCLUDED

SEE INSTALLATION SHEET FOR ADDITIONAL INFORMATION

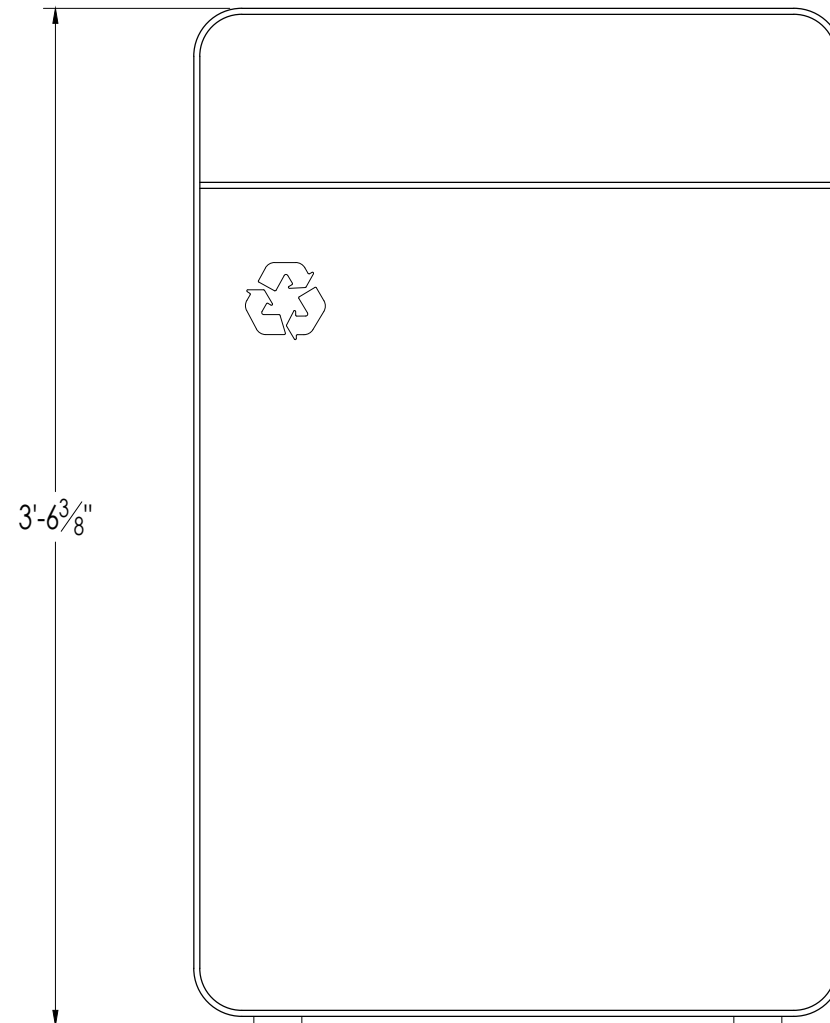
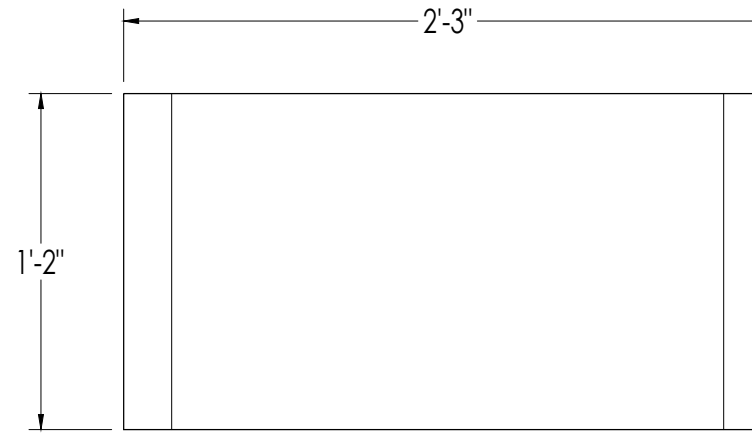

BACK

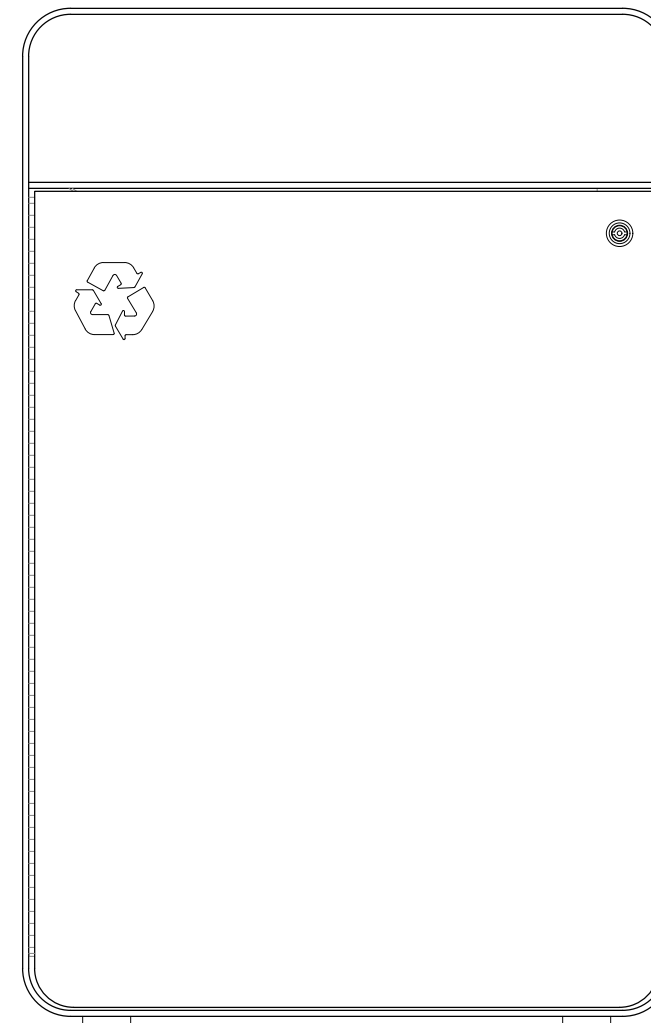

FRONT

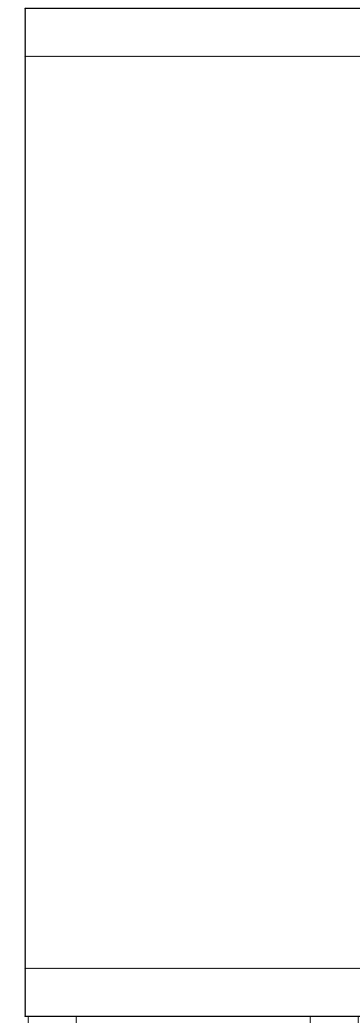

site pieces

ALL DIMENSIONS ARE NOMINAL
ANY AND ALL INFORMATION ON THIS DRAWING
MAY BE PROPRIETARY TO SITE PIECES, LLC
AND MAY NOT BE COPIED OR ALTERED WITHOUT
PERMISSION FROM SITE PIECES, LLC.
3575 RINGSBY COURT #418 DENVER, CO 80214

PRODUCT: MONOLINE 36-GAL LITTER BIN - RECYCLING
PRODUCT #: ML-LGLITTER-R

SIZE: 27" X 14" X 42"
APPROXIMATE WEIGHT: 55 LBS
SCALE: 1-1/2"=1'0"

CREATION DATE: 2022-02-24
UPDATED: 10/30/2024

SHEET: 1/1

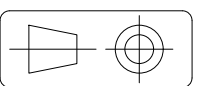

PRODUCT SPECIFICATIONS

ALL ALUMINUM FRAME CONSTRUCTION

POWDER COAT COLOR

(FRAME): _____

(ICON): _____

MOUNTING TYPE:

SURFACE MOUNTED

RISER MOUNT

EMBEDDED

PRODUCT SHIPS FULLY ASSEMBLED

MOUNTING HARDWARE NOT INCLUDED

SEE INSTALLATION SHEET FOR ADDITIONAL INFORMATION

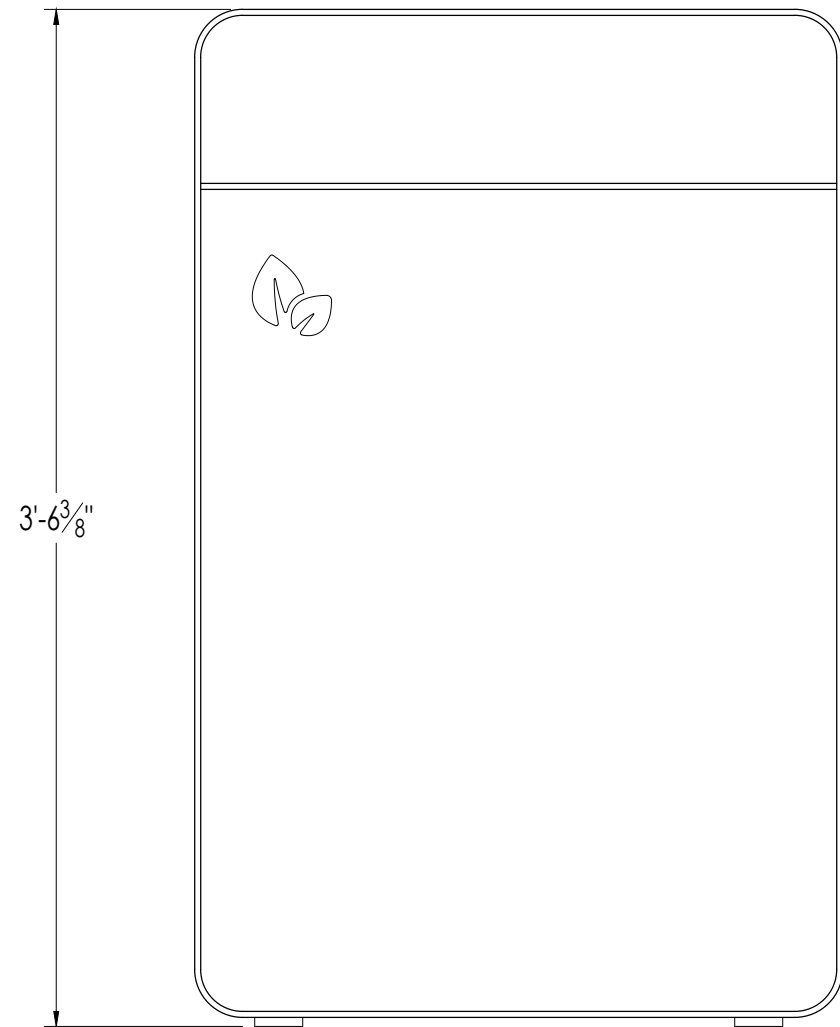
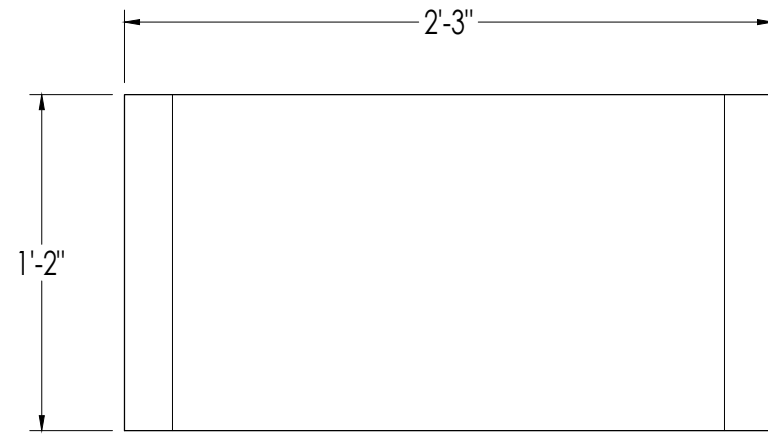

BACK

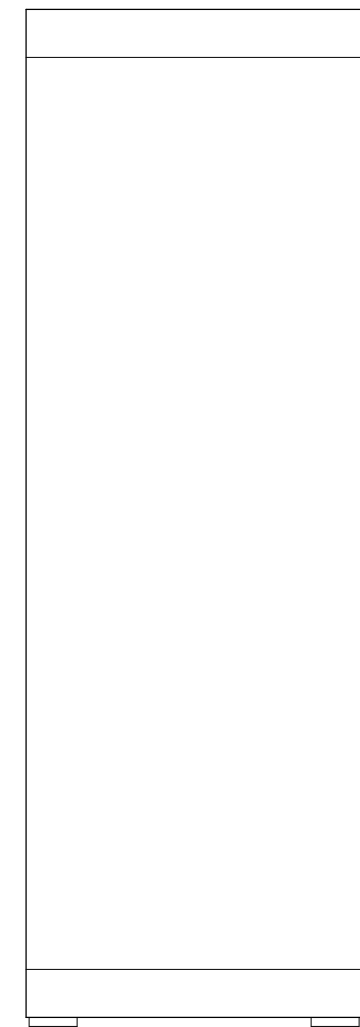
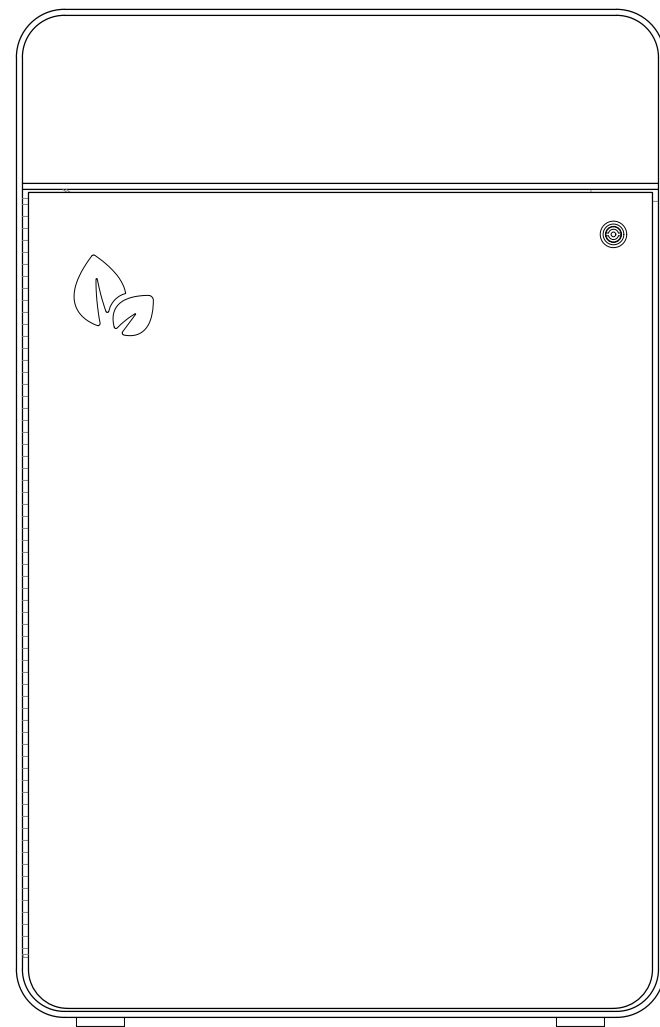

site pieces

ALL DIMENSIONS ARE NOMINAL
ANY AND ALL INFORMATION ON THIS DRAWING
MAY BE PROPRIETARY TO SITE PIECES, LLC
AND MAY NOT BE COPIED OR ALTERED WITHOUT
PERMISSION FROM SITE PIECES, LLC.
3575 RINGSBY COURT #418 DENVER, CO 80214

PRODUCT: MONOLINE 36-GAL LITTER BIN - COMPOST
PRODUCT #: ML-LGLITTER-C

SIZE: 27" X 14" X 42"
APPROXIMATE WEIGHT: 55 LBS
SCALE: 1-1/2"=1'0"

CREATION DATE: 2022-02-24
UPDATED: 11/15/2024

SHEET: 1/1

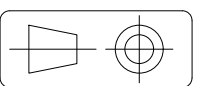

PRODUCT SPECIFICATIONS

ALL ALUMINUM FRAME CONSTRUCTION

POWDER COAT COLOR

(FRAME): _____

(ICON): _____

MOUNTING TYPE:

SURFACE MOUNTED

RISER MOUNT

EMBEDDED

PRODUCT SHIPS FULLY ASSEMBLED

MOUNTING HARDWARE NOT INCLUDED

SEE INSTALLATION SHEET FOR ADDITIONAL INFORMATION

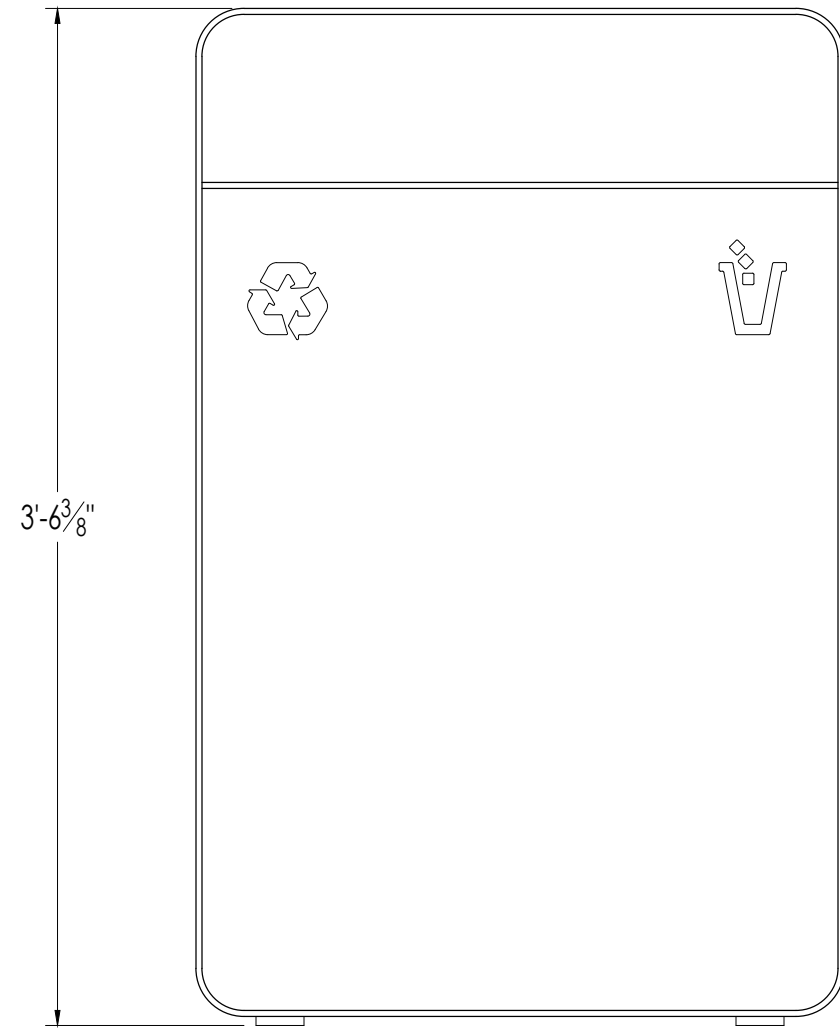
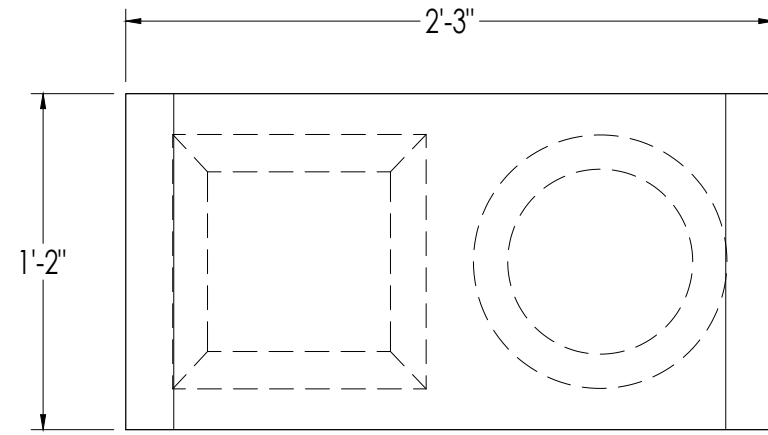

BACK

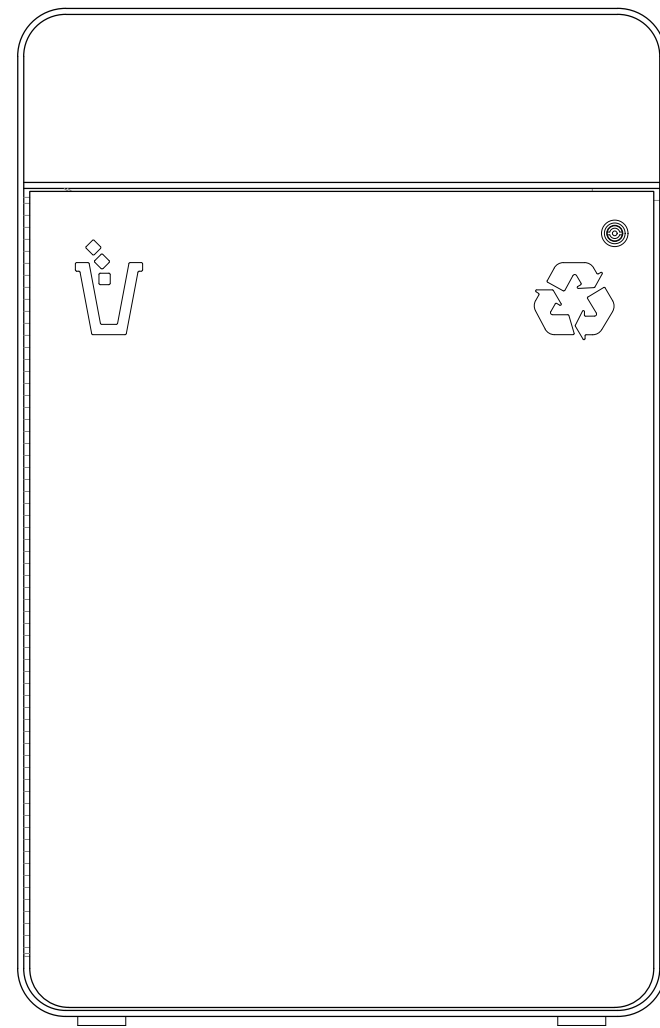

FRONT

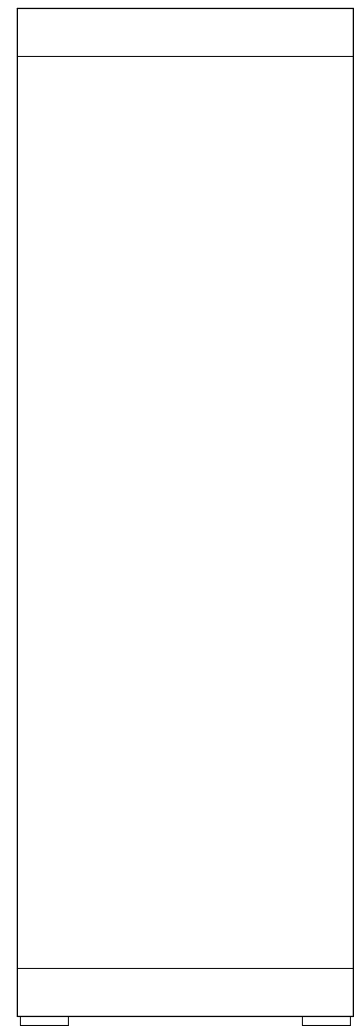

site pieces

ALL DIMENSIONS ARE NOMINAL
ANY AND ALL INFORMATION ON THIS DRAWING
MAY BE PROPRIETARY TO SITE PIECES, LLC
AND MAY NOT BE COPIED OR ALTERED WITHOUT
PERMISSION FROM SITE PIECES, LLC.
3575 RINGSBY COURT #418 DENVER, CO 80216

PRODUCT: MONOLINE 36-GAL LITTER BIN - DUAL STREAM
PRODUCT #: ML-LGLITTER-DL

SIZE: 27" X 14" X 42"
APPROXIMATE WEIGHT: 55 LBS
SCALE: 1-1/2"=1'0"

CREATION DATE: 2022-02-24
UPDATED: 10/30/2024

SHEET: 1/1

